



Vista, CA 92081
www.directed.com

The company behind Viper® Auto Security Systems
is Directed Electronics.

Since its inception, Directed Electronics has had one purpose, to provide consumers with the finest vehicle security and car stereo products and accessories available. The recipient of nearly 100 patents and Innovations Awards in the field of advanced electronic technology, Directed Electronics is ISO 9001 registered.

Quality Directed Electronics products are sold and serviced throughout North America and around the world.

Call **(800) 876-0800** for more information about our products and services.

© 2011 Directed Electronics. All rights reserved.

G5202V 2011-03



VIPER®

NO ONE DARES COME CLOSE™



Directed Electronics is an
ISO 9001 registered company.

Directed Electronics is committed to delivering world class quality products and services that excite and delight our customers.

OWNER'S GUIDE

M O D E L
5701

Congratulations

Congratulations on the purchase of your state-of-the-art remote start and security system. Reading this Owner's Guide prior to using your system will help maximize the use of your system and its many features. For more information please visit the below website:

<http://www.viper.com> – For general and additional guide information.

For any additional questions please contact your authorized Directed dealer or contact Directed at **1-800-753-0600**.

What you get

Welcome to the best generation of security with remote start. Your system contains everything you need.

- Responder LE remote control
- 1-way Companion remote control
- Owner's guide
- Quick reference card
- Warranty card

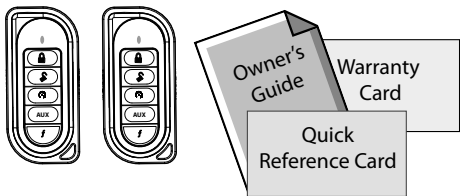

Important information

Government Regulations and Safety information



Read the *Government Regulations* and *Warning! Safety First* sections of this manual prior to operating this system.

Warning! Failure to heed this information can result in death, personal injury or property damage and may also result in the illegal use of the system beyond its intended purpose.

Your Warranty

Your Responder LE system comes with a warranty. Please make sure you receive the warranty registration card and proof of purchase from your dealer indicating the product was installed by an authorized Directed dealer. Your product warranty must be validated within 10 days of purchase. You can validate it online at www.prodregister.com/directed or complete and return the warranty registration card.

Quick Reference Card

Carry this card with you to reference your system's many features.

Replacement remote controls

If additional remote controls are desired, please see your authorized dealer or visit us at www.directedstore.com to order. Part numbers are: 7251V for Responder LE 2-way remote control and 7152V for the companion remote control.

Contents

| | |
|-------------------------------------|----|
| Getting Started..... | 4 |
| Keys to using this manual..... | 4 |
| Responder LE 2-Way..... | 5 |
| Using your System..... | 7 |
| Commands and Confirmations..... | 7 |
| Performing Commands..... | 7 |
| Remote Control Command table..... | 8 |
| Fault Condition Alerts..... | 8 |
| Basic Commands (Direct Access)..... | 10 |
| Arm..... | 10 |
| Disarm..... | 10 |
| Remote Start..... | 11 |
| AUX/Trunk..... | 11 |
| Advanced Commands: (Level 1)..... | 12 |
| Silent Arm..... | 12 |
| Runtime Reset..... | 12 |
| AUX 1..... | 13 |
| Temperature Request..... | 13 |
| Advanced Commands: (Level 2)..... | 14 |
| Sensor Bypass..... | 14 |
| Remote Valet..... | 14 |
| Timer Start..... | 15 |
| AUX 2..... | 15 |
| Arm Status..... | 15 |
| Advanced Commands: (Level 3)..... | 16 |
| Sensor Silent Arm..... | 16 |
| Smart Start..... | 16 |
| AUX 3..... | 17 |
| Runtime Remaining..... | 17 |
| Advanced Commands: (Level 4)..... | 18 |
| Full Silent Arm..... | 18 |
| Defogger..... | 18 |
| AUX 4..... | 18 |
| Remote Control Configuration..... | 19 |
| Remote Programming..... | 19 |
| Remote Pairing..... | 19 |
| Remote Features..... | 20 |
| Car 2..... | 22 |
| Remote Beep..... | 22 |
| Sensor Adjust..... | 23 |

| | |
|--|----|
| Alarm Features | 24 |
| Normal Arm Protection | 24 |
| Sensor Silent Arm protection | 24 |
| Full Silent Arm Protection | 25 |
| Sensor Warn-away | 25 |
| Full Trigger..... | 25 |
| Emergency Override | 25 |
| Trigger Zone Fault Report..... | 26 |
| Alarm Report..... | 26 |
| Nuisance Prevention (NPC)..... | 27 |
| Remote Start Features | 28 |
| Pit Stop Mode | 28 |
| Key Takeover..... | 28 |
| Remote Start Safe-lock | 29 |
| Disabling Remote Start | 29 |
| Advanced Start | 29 |
| Temperature Reporting..... | 30 |
| Remote Start Time-out Alert..... | 31 |
| Manual Transmission Start (MTS mode) | 31 |
| Turbo Timer Mode..... | 32 |
| Remote Start Faults..... | 32 |
| Remote and System Operations | 34 |
| Passive Arming..... | 34 |
| Auto Re-arming..... | 34 |
| Valet Mode | 35 |
| Power Save..... | 35 |
| Rapid Resume | 35 |
| Automatic Remote Updates | 35 |
| Out of Range | 36 |
| No Remote Output..... | 36 |
| Feature not Available | 36 |
| Car Select..... | 37 |
| System Expansion Options | 38 |
| Battery Information..... | 40 |
| Low Battery | 40 |
| Battery Life..... | 40 |
| Battery Disposal | 41 |
| Glossary of Terms..... | 42 |
| Government Regulations | 44 |

| | |
|--|----|
| Warning! Safety First..... | 46 |
| Installation | 46 |
| Remote Start Capable | 46 |
| Manual Transmission Vehicles | 46 |
| Interference..... | 48 |
| Upgrades | 48 |
| Water/Heat Resistance | 48 |
| Limited lifetime consumer warranty | 49 |

Getting Started

Keys to using this manual

Specific actions (in bold type) and style conventions are used consistently throughout this manual, they are as follows:

- **Press:** implies pushing in and releasing a button.
- **Hold:** is used after Press actions when a button needs to be held in position for an extended period of time, typically several seconds.
- *Italicized* words denote section/sub headings in this guide and can be located through the table of contents.
- An asterisk (*) when used after a word or phrase denotes that additional details can be found in related sections usually noted at the bottom of the page or end of the section.
- Ghost LED's are identified by the command/function button they are associated with.

Responder LE 2-Way

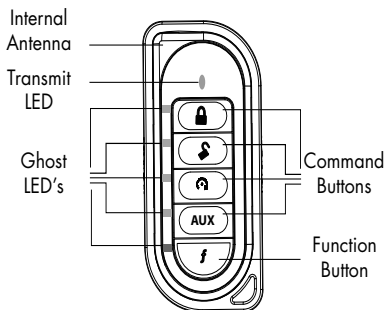

| Feature | Description |
|---------------------|--|
| Internal Antenna | Used for transmitting and receiving* information |
| Command buttons (4) | Used to perform arming, disarming, auxiliary channel and remote start commands |
| Function button | Used to access function levels for commands, configuration menus for programming, Car Selection, and to request reports. |
| Ghost LED's ** | Each button has an associated LED next to it that are active during related operations. These LED's are labeled respectively as: Arm LED, Disarm LED, Remote Start LED, Aux LED, and f LED |

* 2-way communication is only applicable to the Responder LE remote control

** Term denotes that these LED's are only visible when On (Ghost LED's are only applicable to the Responder LE remote control).

Control Center

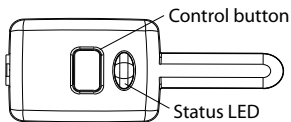

The Control Center, typically located on the upper part of the front windshield sends and receives commands or messages to and from your system. It consists of:

- The In-vehicle system antenna, for 2 way communication.
- The Status LED, as a visual indicator of the system's status.
- The Control button, for placing the system into Valet Mode* and to perform the Emergency Override** operation.

* See *Remote and System Operations* section for details.

** See *Alarm Features* for details.

Using your System

Commands and Confirmations

Commands, Basic or Advanced, are used to activate system features and are performed by pressing one of the Command buttons. Basic commands control the most often used security and remote start features while Advanced commands control more specialized features and request reports.

Confirmations for Basic or Advanced commands are indicated first by siren chirps and parking light flashes, and then by illuminated Ghost LED's and beeps or tones on the remote control. A description of each feature confirmation is found in the following Basic command and Advanced command sections.

Performing Commands



Perform Basic commands by pressing a Command button (Ghost LED's are off).

Perform Advanced Commands by first accessing Levels 1-4 using the **f** button and then by pressing a Command button while within a Level (Levels are indicated by illuminated ghost LED's after pressing **f** button).

Advanced command example: Silent Arm

1. Press the **f** button once to access Function Level 1, the **f** LED turns on.
2. Press the  button while the **f** LED is still on to perform the Silent Arm command.
3. The Arm LED will illuminate to confirm when the Silent Arm message from the system is received.

Remote Control Command table

| Level Button | Direct Access | f × 1 LEVEL 1 | f × 2 LEVEL 2 | f × 3 LEVEL 3 | f × 4 LEVEL 4 |
|---|--|-------------------------|-------------------------|-------------------------|-------------------------|
|  | Arm/Lock (Panic) | Silent Arm | Sensor Bypass | Sensor Silent Arm | Full Silent Arm |
|  | Disarm/Unlock | Silent Disarm | Remote Valet | Car Finder | |
|  | Remote Start | Runtime Reset | Timer Start | Smart Start | Defogger |
| AUX | Aux/Trunk | AUX 1 | AUX 2 | AUX 3 | AUX 4 |
| f | Advance Level, Change Car (3 sec), Enter programming (8 sec) | Temperature Check* | Arm Status* | Runtime Remaining* | |

*Not available for 1-way companion remote control

Fault Condition Alerts

If, when performing a command, a condition exists that does not allow activation of an Alarm feature* or Remote Start feature**, the **f** LED and a fault tone plays to alert of the fault condition.

- * Alarm feature not available when the system status is incorrect upon receiving the command. (Example: Sensor bypass command is received when disarmed).

Refer to the notes included in the following command descriptions that address these faults or go to *Feature not Available* under the *Remote and System Operations* section for more details.

- * * Remote Start feature not available when the Remote Start status is incorrect upon receiving the command. (Example: Runtime reset command received when remote start is off). Refer to the notes included in the command descriptions that address these faults or go to *Remote Start Faults* under the *Remote Start Features* section for more details.

Basic Commands (Direct Access)

No Ghost LED's on

Arm



Press and release 

The alarm arms, doors lock (if connected), and the siren chirps and parking lights flash once. The Arm LED and beeps play to confirm. If Valet mode* is On, the doors lock and the Arm LED, **f** LED and a fault tone plays. Exit Valet mode to arm the alarm normally.

If a trigger zone fault is detected the siren chirps once again and the remote will emit a Trigger Zone Fault Report**, the Arm LED, **f** LED and a fault tone plays.

To Arm and Panic

Press and hold 

The alarm Arms (or Locks in Valet) and, after 2 seconds, sounds the siren and flashes the parking lights. The ghost LED's flash and siren tones play to confirm. Press the  or  button to stop the output.

Disarm

Press and release 

The alarm disarms, doors unlock (if connected), and the siren chirps and parking lights flash twice. The Disarm LED and beeps play to confirm. If Valet mode* is On, the doors unlock and the Disarm LED, **f** LED and fault tones play.

An Alarm Report** will replace the disarm output if the alarm was

triggered; the siren will chirp 4 or 5 times, and the Disarm LED, **f** LED and 4 or 5 fault tones play to alert of the report.

Remote Start

Press and release 

Activates (or if On, deactivates) the remote starter. The engine and parking lights turn On and the Remote start LED and On tones play, or the engine and parking lights turn Off and the Remote start LED and Off tones play to confirm. If a Remote start configuration issue prevents the engine from starting, the **f** LED and a fault tone will play while the parking lights flash a Remote Start fault report*** to identify the fault.

AUX/Trunk

Press and hold **AUX**

The Trunk opens (if connected) when this button is pressed for 2 seconds. The Aux LED and tones play to confirm.

* See *Remote and System Operations* for details.

** See *Alarm Features* for details.

*** See *Remote Start Faults* (under *Remote Start Features*) for details.

For Manual transmission vehicles see *Manual Transmission Start* in the *Remote Start Features* section for more details.

Advanced Commands: (Level 1)

Press and release the **f** button 1 time. The **f** LED illuminates indicating Level 1

Silent Arm

Press and release 

The alarm arms, doors lock (if connected), and the parking lights flash once. The Arm LED turns on to confirm. Valet mode* or Trigger Zone Fault Report** messages may be received.

Silent Disarm

Press and release 

The alarm disarms, doors unlock (if connected), and the parking lights flash twice. The Disarm LED turns on to confirm. The Silent Disarm output may be replaced by the Alarm Report**

Runtime Reset

Press and release 

If more time is needed while remote start is active, runtime reset will reset the runtime counter to the pre-programmed setting. The green ghost LED's show the runtime and the Remote start On tones play to confirm runtime reset.

Note Remote Start must be On to use this feature.

AUX 1

Press and release **AUX**

Activates (or if On, deactivates) the Aux 1 output. The Aux LED and On tones or Off tones play to confirm.

Temperature Request

Press and hold the **f** button

Requests the vehicle's interior temperature and displays it by illuminating the green ghost LED's; cold is 1 LED, cool (2), warm (3), warmer (4)

* See *Remote and System Operations* section for details.

** See *Alarm Features* for details.

Advanced Commands: (Level 2)

Press and release the **f** button 2 times. The **f** and Aux LED's illuminate indicating Level 2

Sensor Bypass

Press and release 

Performing the Sensor Bypass command will incrementally bypass sensor operations and be confirmed as follows:

- **Warn-away bypass:** The Parking lights flash 2 times. The Arm LED, 1 beep and 1 fault tone play to confirm. Sensors will be activated for Full Trigger levels of impact only.
- **Warn-away & Full trigger bypass:** The Parking lights flash 3 times. The Arm LED, 1 beep and 2 fault tones play to confirm. Sensors will not be activated for any level of impact.
- **Sensor Bypass off:** The Parking lights flash 1 time. The Arm LED and 1 beep play to confirm. Sensors are fully operational.

| | |
|-------------|---|
| Note | System needs to be armed to perform Sensor Bypass. Perform arm command any time to turn Sensor Bypass Off. |
|-------------|---|

Remote Valet

Press and release 

Enters (or if On, exits) Valet Mode. The Control Center LED turns on and off accordingly. The Disarm LED and Valet beeps play (1 for on, 2 for off) to confirm.

Timer Start*

Press and release 

Activates (or if On, deactivates) Timer Start. The parking lights flash quickly four times for On and slowly four times for Off. The Remote Start LED and beeps play (1 for on, 2 for off) to confirm..

| | |
|-------------|--|
| Note | System needs to be armed or Timer Start will not start the engine. |
|-------------|--|

AUX 2

Press and release **AUX**

Activates (or if On, deactivates) the Aux 2 output. The Aux LED and On tones or Off tones play to confirm.

Arm Status

Press and hold the **f** button

The remote will generate an output using the LED's and beeps/tones to display the systems Arm Status since its last update message or command operation. It will report status via ghost LED's, beeps, and tones as described in this section for Arm, Disarm, Valet mode arm, Valet mode disarm, Sensor Silent arm, Full Silent arm.

* See *Advance Start* under *Remote Start Features* for details.

Advanced Commands: (Level 3)

Press and release the **f** button 3 times. The **f**, Aux and Remote Start LED's illuminate indicating Level 3

Sensor Silent Arm*

Press and release 

The alarm arms, doors lock, and the siren chirps and parking lights flash 3 times. The Arm LED, 1 beep and 3 fault tones play to confirm.

Car finder

Press and release 

The siren emits one long chirp and the parking lights flash for 10 seconds. The Disarm LED and 1 beep play to confirm. The parking light flashes stop if armed or disarmed while Car Finder is in progress.

Smart Start**

Press and release 

Activates (or if On, deactivates) Smart Start. The parking lights flash quickly five times for On and slowly five times for Off. The Remote Start LED and beeps play (1 for on, 2 for off) to confirm.

| | |
|-------------|--|
| Note | System needs to be armed or Smart Start will not start the engine. |
|-------------|--|

AUX 3

Press and release **AUX**

Activates (or if On, deactivates) the Aux 3 output. The Aux LED and On tones or Off tones play to confirm.

Runtime Remaining

Press and hold the **f** button

Requests the remaining Remote start runtime and temporarily displays it in 4 increments using the green Ghost LED's.

Example for 12 minute runtime:

- 3 LED's: 6 to 9 minutes remaining (50 - 75% of time selected).
- 1 LED: less than 3 minutes remaining (<25% of time selected).

Note Remote Start must be On to use this feature.

* See *Alarm Features* for more details.

** See *Advance Start* under *Remote Start Features* for details.

Advanced Commands: (Level 4)

Press and release the **f** button 4 times. The **f**, Aux, Remote Start and Disarm LED's illuminate indicating Level 4

Full Silent Arm*

Press and release 

The alarm arms, doors lock, and the siren chirps and parking lights flash 4 times. The Arm LED, 1 beep and 4 fault tones play to confirm.

Defogger**

Press and release 

Activates the vehicle Defogger circuit (if connected) while Remote Start is activated and the parking lights flash 3 times. The Remote start LED and 1 beep play to confirm. For convenience, the Defogger circuit will also automatically activate 10 seconds after remote starting if the temperature is below 55°F.

Note Remote Start must be active to use this feature.

AUX 4

Press and release **AUX**

Activates (or if On, deactivates) the Aux 4 output. The Aux LED and On tones or Off tones play to confirm.

* See *Alarm Features* for more details.

** This feature must be installed and turned on by an authorized Directed dealer.

Remote Control Configuration

Remote Programming

The Responder LE and 1-way companion remote controls have operations that can be configured to a user's personal preferences. The following instruction will direct you through the available programming options for both remotes.

Enter programming, **press** and **hold** the **f** button for 8 seconds, the remote emits one long beep and the transmit LED turns on to indicate the Main Menu is accessed.

Exit programming or go back to a previous menu, **press** and release the **f** button. 1 short and 1 long beep is emitted for each step back and when programming is exited the transmit LED turns off.

Remote Pairing



The following instruction will step you through the remote pairing operation.

Prepare the vehicle system for pairing:

1. **Open** at least one of the vehicle's doors.
2. **Turn** the key to the ON position.
3. Within 5 seconds **press** and release 1 time the Control button on the Control Center.
4. Within 5 seconds, **press** and **hold** the Control button. The status LED will flash one time and the siren will chirp once to confirm the system is ready for remote pairing.
5. **Release** the Control button and proceed below.
Pairing will exit if:
 - Step 7 below is not completed within 60 seconds
 - The doors are closed

- The ignition is turned off.

Prepare the remote control for pairing:

6. Enter programming to access the Main Menu
7. **Press** and **hold** the  button for 1 second, 3 transmit LED flashes and 3 beeps indicate remote is ready to pair.
8. **Press** the  button,

Responder LE: the siren will chirp and the remote will emit several tones to confirm pairing is complete. If the remote does not emit the tones repeat step 7.



1-way companion: the siren will chirp to confirm the system has learned the remote control.

Remote Features

Press the  button to access the remote operation features, 2 transmit LED flashes and 2 beeps indicate the remote features menu is accessed. **Press** the buttons indicated in the tables below to set the feature option.



Responder LE

The Ghost LED's next to the button indicate the feature settings.

| Feature | Button Press | LED on | LED off | LED Flash | LED Double Flash |
|--------------|---|-----------|------------|---------------|------------------|
| Keypad lock |  | Auto | Off | | |
| Remote Beeps |  | Beeps On | Beeps Off | Triggers only | |
| Car 2 |  | Car 2 On | Car 2 Off | | |
| Page Mode* | AUX | Paging On | Paging Off | Power Save 1 | Power Save 2 |

1-way companion remote control

The 1-way remote will flash the transmit LED to indicate the setting.

| Feature | Button Press | LED on | LED off |
|--------------|---|----------|-----------|
| Keypad Lock |  | Auto | Off |
| Remote Beeps |  | Beeps On | Beeps Off |
| Car 2 |  | Car 2 On | Car 2 Off |

Keypad Lock

Options: Off, Auto

When Off, the buttons do not lock and always perform a command when pressed. When set to Auto, the remote buttons lock after a 20 second lapse between buttons presses to prevent unintentional operations. If a button is pressed when locked the **f** LED and a fault tone play as an alert. The 1-way companion emits the fault tone only. To unlock the buttons, press the **f** button followed by the  button. The Ghost LEDs flash and tones play to confirm unlocking.

Auto unlocking

After turning the ignition off, a message to the Responder LE will unlock the keypad buttons until the next command is performed. If Auto Unlocking is not desired this message can be turned off by an authorized Directed Dealer.

Page Mode

Options: Power Save 1, Power Save 2, On, Off

Paging is how the Responder LE remote monitors your system's messages. Power Save extends battery life by turning Paging Off after 72

hours if the remote control is not used during this period. Just press any button to resume system monitoring. Power Save 2 is for maximum battery life and will monitor the system only when remote start has been activated. **Caution:** Alarm trigger messages will not be received when remote start is off. When set to On it wakes up every few seconds to listen for pages from the system. When set to Off it does not wake up to receive remote start or alarm trigger pages.

Note: When Off, responses are still received when a command is performed but alarm trigger pages will not be received.

Car 2

Options: Off, On

The Responder LE and 1-way companion remote controls can control two systems independently. When set to Off, the Car Select feature is not available. When set to On the Car Select feature is enabled. See "Car Select" (under *Remote and System Operations*) for detail on using a remote with 2 systems.

Remote Beep

Options: On, Off, Triggers Only

The Responder LE will emit a beep as confirmation of button presses and command responses. When set to Off, beeps are not emitted for any operations except programming. For Triggers Only, beeps will only be emitted for Full Trigger messages.

For 1-way companion remote control, Off will delete all beeps except when programming.

Sensor Adjust

The  button is used for sensor adjustment, to avoid unintended alarm triggers; it is recommended that an authorized Directed Dealer performs all sensor adjustments.

Alarm Features

Normal Arm Protection

Status LED: The Control Center Status LED flashes as a visual indicator that your vehicle's security system is active.

Starter Kill: The Failsafe starter kill relay prevents the engine from starting

Note May require additional parts and installation

Sensor triggers: The onboard shock sensor can distinguish minor impacts from major impacts to the vehicle exterior. Minor impacts causes the system to emit a Warn-away output by chirping the siren and flashing the parking lights for 3 seconds. Major impacts caused for example by a forcible entry attempt, results in a Full Trigger output. The siren sounds and the parking lights flash for 30 seconds or longer. Both Warn-away and Full Triggers send a message to the remote control.

Point of entry triggers: Opening the hood or trunk causes a Full Trigger output, while opening a Door or turning on the Ignition causes the the siren to chirp 3 seconds before beginning the Full Trigger output. This 3 second delay allows time to disarm and silence the siren in case of accidental trigger. The Full Trigger message is still sent to the remote.

Sensor Silent Arm protection

Sensor Warn-away and Sensor Full Trigger activations only send messages to the remote, while the parking light flash and siren outputs are defeated. Point of entry triggers will activate the parking light flash, siren, and send messages normally.

Full Silent Arm Protection

Sensor Warn-away, Sensor Full Trigger and Point of Entry activations will only send messages to the remote, with parking light flash and siren outputs defeated.

Sensor Warn-away

When the system sensors detect a Warn-away trigger the siren chirps and parking lights flash for 3 seconds. No messages are sent to the Responder LE remote control for Warn-away triggers.

Full Trigger

An alarm Full Trigger will sound the siren and flash the parking lights for 30 seconds while sending a Full Trigger message to the remote control. The ghost LED's flash and siren tones play for 30 seconds followed by an alert that consists of 1 long beep per minute for 10 minutes.

To stop the output and alert, **press** a command button to perform a command, or **Press** the **f** button.

Emergency Override

The following procedure disarms the system when a programmed remote is not available. Number of presses _____

1. **Turn** the ignition On.
2. **Press** the control button on the Control Center the correct number of times (the default is 1 press).
3. After a few seconds the siren output ceases and the system is disarmed.

Note

As a precaution, if programmed for Passive Arming or Auto re-arming the system should be placed into Valet Mode until a remote is available .

Trigger Zone Fault Report

When armed by remote command the system runs a status check of the alarm trigger zones. Faulty zones (usually caused by dome light delay or open trunk) are bypassed and reported via the control center LED and remote, while all other trigger zones remain active and are monitored to protect the vehicle. Should a faulty zone self correct (dome light turns off) it becomes active and is then monitored normally.

The siren chirps once again a few seconds following the arming chirps as an audible alert, the control center LED flashes in groups to indicate the zone number.

Alarm Report

If the alarm was triggered while armed, it will be reported when the alarm is disarmed via the remote control, siren chirps, parking light and control center LED flashes. The siren chirps 4 times (or 5 times if NPC On*), the parking lights flash 3 times, and the control center LED flashes in groups to indicate the last two zones that were triggered (see Table of Zones). The report output will repeat for each disarm operation until the ignition is turned on.

* See *Nuisance Prevention (NPC)* for more details.

Table of Zones

| Zone # (led flashes) | Zone Name |
|----------------------|--------------|
| 1 | Trunk |
| 2 | Shock Sensor |
| 3 | Door |
| 4 | Sensor 2 |
| 5 | Ignition |
| 6 | Hood |

Nuisance Prevention (NPC)

NPC monitors all alarm zones and, if any are triggered excessively, bypasses them until corrected. If a point of entry (trunk, hood, door) is left open following a forced entry, it is bypassed. It becomes active again only after being closed.

Bypassed sensors automatically reset after one hour and after the vehicle is driven. Disarming then re-arming the alarm does not reset bypassed sensors.

Remote Start Features

Pit Stop Mode

To exit vehicle with engine running

The system keeps the engine running during short trips into the house or convenience store. To perform Pit Stop:

1. With the engine running, **set** the parking brake and **release** the foot brake.
2. **Press** the  button, the parking lights will turn on and the Remote start LED and On tones play on the remote control.
3. **Turn** the key to off, and **remove** it from the ignition, the engine continues running for the programmed runtime.
4. **Exit** the vehicle and **arm** the alarm.

Note For Pit Stop on manual transmission vehicles follow the directions in the *Manual Transmission Start (MTS mode)* section.

Key Takeover

When you are ready to drive

The system keeps the engine running until the vehicle is ready to be driven. To perform Key Takeover:

1. **Disarm** the system and **enter** the vehicle, do not step on the foot brake.
2. **Insert** the key, **turn** it to the run position, and then **step** on the foot brake, the remote start then turns off.
3. The parking lights turn off to indicate remote start is off, and then

after a few seconds the remote plays the Remote Start Off message.

4. The vehicle is ready to drive.

Remote Start Safe-lock

Remote start safe-lock makes sure the doors are locked while the engine is running and after, even if they are unlocked when remote start is activated. Door locks may require additional parts and labor.

Disabling Remote Start

Remote start can be disabled by moving the Toggle Switch to the Off position. If remote start is attempted while Off, the engine will not start. (See *Remote Start Fault* under *Remote Start Features*) move the switch back to the On position to resume normal operation.

Advanced Start

The Advanced start features; Timer Start and Smart Start will automatically start the engine to maintain battery charge or combat extreme cold when parked for an extended period of time.

Precautions for the Advanced Start features:

- Park the vehicle in a well ventilated area away from windows and doors that lead into inhabited spaces.
- Arm and Lock the vehicle, the engine will not start unless the doors are locked.
- Only one Advanced start feature can be enabled at any given time.
- For manual transmission vehicles MTS mode must be enabled before Timer Start or Smart Start can be activated.

Timer Start operation

Activation begins a countdown timer as set by the installer (default 3 hours). When the timer expires the engine starts and the Remote Start On message is sent to the remote control. When the Remote start runtime expires the engine shuts off, the Remote Start Off message is sent to the remote control and the countdown timer restarts. This will repeat as many times as set by the installer (default 6 starts). Timer Start is exited after the final start.

Smart Start operation

Smart Start uses the settings for Timer Start in addition to temperature and battery level to automatically start the engine. Activation begins the countdown timer. When the timer expires the vehicle interior temperature and battery level is checked and, if the Temperature is above 100F, below 0F, or the battery level is below 10.5v, the engine will start and the Remote Start On message will be sent to the remote controls. When the Remote start runtime expires the engine shuts off, the Remote Start Off message is sent to the remote control and the countdown timer restarts. Smart Start is exited after the final start.

| | |
|-------------|---|
| Note | The temperature and battery thresholds can be changed by an authorized Directed dealer if a higher or lower threshold is desired. |
|-------------|---|

Temperature Reporting

During Remote start the vehicle interior is checked regularly for temperature changes. If a change in temperature is detected this report will be sent to the remote for display. Each time the remote receives this report it will beep and display the temperature as described for the Temperature Request in the Advanced Commands section Level 1.

Note Temperature report must be turned on by an authorized Directed dealer.

Remote Start Time-out Alert

During remote start a message is sent three minutes before and again at one minute before the engine turns off. The **f** LED, Remote Start LED flash and several tones play as an alert to reset the runtime if desired.

Manual Transmission Start (MTS mode)

When installed into a manual transmission vehicle, the system requires that the MTS mode is properly set when parking. If MTS mode is not properly set or is defeated after being properly set the system will not start the engine.

1. With the engine running, **set** the parking brake and leave the engine running. For Pit Stop or Turbo Timer mode (to leave the engine running after arming), **open** the driver door.
2. **Release** the foot brake (if pressed during Step 1), or **press** and **release** the foot brake anytime. As long as the engine is running there is no time limit to perform this step.
3. Within 20 seconds of foot brake release, **press** any command button on the remote, after 20 seconds return to Step 2 (For Turbo Timer Mode, press the optional dash mounted activation button or send the Timer Mode command).
4. The parking lights flash 5 times to confirm MTS mode enable and the remote start activates the ignition outputs. The Remote Start LED and On tones play to confirm.
5. **Turn Off** and **remove** the key from the ignition switch, the engine remains running.
6. **Exit** the vehicle, **close** all the doors and **arm** the system.

7. The engine turns off and after a few seconds, the Remote Start LED and Off tones play to confirm. If the door is opened in Step 3 then the engine continues to run.

Turbo Timer Mode

The system keeps the engine running for the Turbo Timer runtime and can be activated by remote control or optional dash mounted activation button.

1. With the engine running, **set** the parking brake.
2. **Press** the optional dash mounted activation button or perform the Timer Mode command.
3. The parking lights turn on and the remote start activates the ignition outputs. The Remote Start LED and On tones play to confirm.
4. **Turn** Off and **remove** the key from the ignition switch, the engine remains running.
5. **Exit** the vehicle, **close** all the doors and **arm** the system.
6. The engine runs for the Turbo Mode runtime.

| | |
|-------------|---|
| Note | Turbo Timer must be turned on by an authorized Directed dealer. |
|-------------|---|

Remote Start Faults

For user safety, the system must be properly configured or remote start will not activate. The Remote Start Fault output (**f** LED on and long fault tone) may be caused by any of several configuration issues. Refer to the following table for the command type and parking light flashes that will identify the configuration issue and solution.

| Flashes * | Possible Fault | Solution |
|-----------|---|-----------------------|
| 5 | Brake on | Release foot brake |
| 6 | Hood open | Close hood |
| 7 | After performing Remote Start command - MTS not enabled | Enable MTS mode |
| | After performing Timer Start or Smart Start command | Check all Solutions |
| 8 | Toggle Switch off | Turn switch on |
| None | Alarm is triggered | Disarm or reset alarm |

* Refers to the number of parking light flashes.

Remote and System Operations

Passive Arming*

Park and exit the vehicle, after the doors are closed the Passive arming countdown begins. The led flashes quickly and upon reaching 20 seconds the siren then chirps once. At 30 seconds the system arms itself.

Anytime before the system arms you can re-enter the vehicle or open the trunk to load or unload items and, after closing passive arming resumes.

To stay secure in case of accidental disarming of the system, if a door is not opened within 30 seconds the system re-arms itself and locks the doors.

Auto Re-arming*

Auto re-arm ensures the vehicle stays protected if it is not entered after disarming by remote control. After disarming by remote, the alarm automatically re-arms itself (and locks the doors if programmed on) in 30 seconds. Open any point of entry to stop the re-arm until the next disarm by remote.

Onetime Bypass*

Turn the ignition On for one to three seconds and then Off. The siren chirps once to confirm one-time bypass is enabled.

One-time bypass can be used to temporarily bypass the Passive arming operation for one cycle. It also bypasses the comfort closure and auxiliary channel outputs programmed to activate when arming. After the next disarm all operations return to normal.

* These features must be turned on by an authorized Directed dealer.

Valet Mode

Valet mode can be entered and exited by performing the Remote Valet command or manually using the vehicle key and the control button. When entered, the alarm functions are defeated while the convenience features still operate normally.

Arm and Disarm commands lock and unlock the doors. The Responder LE emits the Arm in Valet and Disarm in Valet output as described for Arm and Disarm in the Basic Commands section.

Use the following steps to manually enter and exit Valet Mode:

1. **Turn** the ignition switch On and then Off
2. Immediately **press** and **release** the control button once
3. The control center LED turns On when entering and Off when exiting.

Power Save

To reduce power consumption the control center status LED modifies its output if the vehicle is parked for an extended period. If Armed the flashing is reduced after 24 hours. When Valet mode is On the LED will turn off 1 hour and will reset each time the ignition is turned off.

Rapid Resume

If power is ever disconnected by a mechanic or thief, the system will resume the state it was in at the time of disconnection, when power is reconnected.

Automatic Remote Updates

The system sends a silent message to all remote controls after any major action has occurred. When the remote receives this message it updates the Arm status.

Out of Range

Each time a command is performed the Responder LE will expect a command confirmation from the system. If a command confirmation is not received the **f** and transmit LED's flash and a long fault tone plays as an alert.

No Remote Output

Occasionally when a command is performed the remote may not generate a command confirmation output or Out of Range output. This indicates that the system received the command but it was an incomplete command (e.g. Aux button pressed too short to activate the trunk release) or it was an illegal message (e.g. the command was corrupted due to local RF interference). These are temporary normal functions of the system and remote, perform the command again within 10 seconds to return to normal operation.

Feature not Available

The Feature Not Available output (**f** LED on and long fault tone) is a generic one which varies in cause and solution depending upon the command used:

| Command | Cause | Reason/Solution |
|---------------|--|--|
| Runtime Reset | Remote Start is Off | Only available when Remote Start is On |
| Sensor Bypass | System is not armed | Only available when system is armed |
| Defroster | Remote Start is Off. Not configured for this. | Only available when Remote Start is On. Only available when configured for Defroster control. |

Car Select

Car 2 must first be turned On (See *Remote Control Configuration* section to turn on).

1. **Press** and **hold** the **f** button for 3 seconds. The remote flashes the LED and beeps once or twice to indicate the selected Car is 1 or 2.
2. **Release** the button for Car Select or continue to **hold** for programming.
3. **Release** the **f** button, then **press** and **release** while the LED and beeps continue to perform Car Select. Once the car is selected a command can be performed by pressing one of the command buttons.

System Expansion Options

Controlling two vehicles (Car Select)

The Responder LE and 1way companion remote can control systems in two different vehicles saving the need for multiple remote controls. This feature also allows for customized system configurations on each vehicle that has more than one driver. See *Owner Recognition* following for details.

Owner recognition

The system can be configured to recognize the remote used when disarming and change selected features to match the remote users preferences. Memory seat adjustment, siren chirps, passive arming, remote button auto unlocking, alarm output duration can all be custom set for each remote user at the time of installation.

Comfort closure

Comfort Closure emulates turning the key in the door cylinder or holding the lock button of an OEM keyless entry. It will automatically close the windows and sunroof on vehicles with this type of OEM convenience feature.

Alarm output duration

The length of time the siren sounds can be adjusted from 1 to 180 seconds at the time of installation.

Arming and Warn-away chirp control

The system Arm, Disarm and Sensor Warn-away chirps can be configured for those that prefer a custom silent alarm operation.

Driver door priority unlocking

The door unlocking operation can be configured to emulate an OEM style of driver priority unlocking for added security during disarming.

Battery Information

The Responder LE remote is powered by 2 batteries (PN CR-2016) and the 1-way companion remote by 1 battery (PN CR-2032) that can be purchased at most retailers. When the battery begins to weaken, the operating range will be reduced. The information and precautions in this section can help maximize your battery's life and usage in providing your Responder LE and 1-way companion remote controls with many years of trouble free operation.

Low Battery

After a command is performed the Responder LE and 1way companion remote controls check their battery level and, when the level requires attention, will begin generating alerts. Once the alerts begin, the remote controls will remain operational for several days but the battery/batteries should be replaced at the earliest opportunity or failure to control the system may occur.

Low Battery Alerts

When disarming the system using a remote with a low battery the siren will emit one additional chirp as an alert. If confirmation chirps are programmed off, the system will still emit one chirp as an alert when disarming. After performing a command, several beeps play on the Responder LE remote to indicate the battery/batteries need replacing.

Battery Life

The Responder LE remote control has many features that make it one of the most unique remote controls on the market today. The default feature settings provide for excellent battery life. However, to maximize this battery life, the following suggestions will help:

- Turn Paging off: The remote will not wake up to check for messages with Paging off in the Setup Remote menu. Caution! The remote will not receive trigger messages from the system.
- Turn Beeps off: The Button beeps can be turned off in the Setup Remote menu. The command beeps still play normally.

Battery Replacement

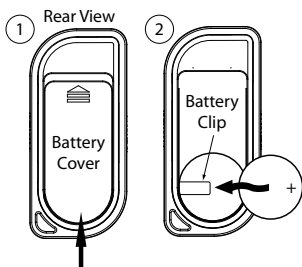

1. Slide the battery cover up by applying equal pressure at its top and bottom (the arrow on the cover indicates the direction), remove the cover from the remote control housing.

2. Gently pry up on the battery to remove it from the holder. Insert a new battery into the holder and under the clip with the positive (+) side up. Replace the battery cover. The remote control is now ready for use.

Battery Disposal



Directed Electronics cares about the environment. If you need to dispose of the battery, please do so in accordance with your municipal requirements for battery disposal or return to Directed Electronics at: One Viper way, Vista, CA 92081 (Shipping and/or handling costs are the sole responsibility of the owner/sender and will not be covered by Directed Electronics).

Glossary of Terms

Document Terminology

| | |
|---|---|
| Control Module | The “brain” of your system. Usually hidden underneath the dash area of the vehicle. It houses the microprocessor which monitors your vehicle and controls all of the system’s functions. |
| Responder LE (2-way Remote Control) | A hand-held, remote control which operates the various functions of your system and receives messages and pages from the system. |
| Companion Remote (1-way Remote Control) | A hand-held, remote control which operates the various functions of your system but does not provide message display.. |
| Control Center | The control center contains the system’s radio-frequency antenna, the control button, and the Status LED. For maximum remote-control range, the control center is usually located at the top of the windshield, centered near the rear-view mirror. |
| Status LED | A light used to indicate the status of your system. It is located on your system’s Control Center. |
| Control Button | A small push button located on your system’s control center. It is used to override (disarm) the alarm when a remote is not available or to enter or exit Valet Mode. |

Government Regulations

This device complies with Part 15 of FCC rules. Operation is subject to the following two conditions: (1) This device may not cause harmful interference, and (2) This device must accept any interference received, including interference that may cause undesirable operation.

This equipment has been tested and found to comply with the limits for a class B digital device, pursuant to Part 15 of the FCC Rules. These limits are designed to provide reasonable protection against harmful interference in a residential installation. This equipment generates and can radiate radio frequency energy and, if not installed and used in accordance with the instruction manual, may cause harmful interference to radio communications. However, there is no guarantee that interference will not occur in a particular installation. If this equipment does cause harmful interference to radio or television, which can be determined by turning the equipment OFF and ON, the user is encouraged to try to correct the interference by one or more of the following measures:

- Reorient or relocate the receiving antenna.
- Increase the separation between the equipment and receiver.
- Connect the equipment into an outlet on a circuit different from that to which the receiver is connected.
- Consult the dealer or an experienced radio / TV technician for help.

Remote Controls

To satisfy FCC RF exposure compliance requirements, this device should be used in hand-held, hand operated configurations only. The device and its antenna must maintain a separation distance of 20 cm or more from the person's body, except for the hand and wrists, to satisfy RF exposure compliance. This device is designed to be used in a person's hands and its operating configurations do not support normal transmissions while it is carried in pockets or holsters next to a person's body.

Control Center

To satisfy FCC RF exposure compliance requirements, the device and its antenna must maintain a separation distance of 20 cm or more from the person's body, except for the hand and wrists, to satisfy RF exposure compliance.

This device complies with the Industry Canada Radio Standards Specification RSS 210. Its use is authorized only on a no-interference, no-protection basis; in other words, this device must not be used if it is determined that it causes harmful interference to services authorized by IC. In addition, the user of this device must accept any radio interference that may be received, even if this interference could affect the operation of the device.

WARNING! Changes or modifications not expressly approved by the party responsible for compliance could void the user's authority to operate this device.

Warning! Safety First



Please read the safety warnings below before proceeding. Improper use of the product may be dangerous or illegal.

Installation

Due to the complexity of this system, installation of this product must only be performed by an authorized Directed dealer. If you have any questions, ask your retailer or contact Directed directly at 1-800-753-0600.

Remote Start Capable

When properly installed, this system can start the vehicle via a command signal from the remote control transmitter. Therefore, never operate the system in an enclosed area or partially enclosed area without ventilation (such as a garage). When parking in an enclosed or partially enclosed area or when having the vehicle serviced, the remote start system must be disabled using the installed menu wheel. It is the user's sole responsibility to properly handle and keep out of reach from children all remote control transmitters to assure that the system does not unintentionally remote start the vehicle. THE USER MUST INSTALL A CARBON MONOXIDE DETECTOR IN OR ABOUT THE LIVING AREA ADJACENT TO THE VEHICLE. ALL DOORS LEADING FROM ADJACENT LIVING AREAS TO THE ENCLOSED OR PARTIALLY ENCLOSED VEHICLE STORAGE AREA MUST AT ALL TIMES REMAIN CLOSED. These precautions are the sole responsibility of the user.

Manual Transmission Vehicles

Remote starters on manual transmission vehicles operate differently than those with automatic transmission because you must leave your car in neutral. You must read this Owner's Guide to familiarize yourself with the proper procedures regarding manual transmission remote starters. If you have any questions, ask your authorized Directed dealer or contact Directed at 1-800-753-0600.

Before remote starting a manual transmission vehicle, be sure to:

- Leave the vehicle in neutral and be sure no one is standing in front or behind the vehicle.
- Only remote start on a flat surface
- Have the parking brake fully engaged

WARNING! It is the responsibility of the owner to ensure the parking/emergency brake properly functions. Failure to do so can result in personal injury or property damage. We recommend the owner have the parking / emergency brake system inspected and adjusted by a qualified automotive shop biannually.

Use of this product in a manner contrary to its intended mode of operation may result in property damage, personal injury, or death. (1) Never remotely start the vehicle with the vehicle in gear, and (2) Never remotely start the vehicle with the keys in the ignition. The user must also have the neutral safety feature of the vehicle periodically checked, wherein the vehicle must not remotely start while the car is in gear. This testing should be performed by an authorized Directed dealer in accordance with the Safety Check outlined in the product installation guide. If the vehicle starts in gear, cease remote start operation immediately and consult with the authorized Directed dealer to fix the problem.

After the remote start module has been installed, contact your authorized dealer to have him or her test the remote start module by performing the Safety Check outlined in the product installation guide. If the vehicle starts when performing the Neutral Safety Shutdown Circuit test, the remote start unit has not been properly installed. The remote start module must be removed or the installer must properly reinstall the remote start system so that the vehicle does not start in gear. All installations must be performed by an authorized Directed dealer.

OPERATION OF THE REMOTE START MODULE IF THE VEHICLE STARTS IN

GEAR IS CONTRARY TO ITS INTENDED MODE OF OPERATION. OPERATING THE REMOTE START SYSTEM UNDER THESE CONDITIONS MAY RESULT IN PROPERTY DAMAGE OR PERSONAL INJURY. YOU MUST IMMEDIATELY CEASE THE USE OF THE UNIT AND SEEK THE ASSISTANCE OF AN AUTHORIZED Directed DEALER TO REPAIR OR DISCONNECT THE INSTALLED REMOTE START MODULE. DIRECTED WILL NOT BE HELD RESPONSIBLE OR PAY FOR INSTALLATION OR REINSTALLATION COSTS.

This product is designed for fuel injected vehicles only. Use of this product in a standard transmission vehicle must be in strict accordance with this guide.

This product should not be installed in any convertible vehicles, soft or hard top with a manual transmission. Installation in such vehicles may pose certain risk.

Interference

All radio devices are subject to interference which could affect proper performance.

Upgrades

Any upgrades to this product must be performed by an authorized Directed dealer. Do not attempt to perform any unauthorized modifications to this product.

Water/Heat Resistance

This product is not designed to be water and/or heat-resistant. Please take care to keep this product dry and away from heat sources. Any damage from water or heat will void the warranty.

Limited lifetime consumer warranty

Directed Electronics. ("Directed") promises to the original purchaser to repair or replace (at Directed's election) with a comparable reconditioned model any Directed unit (hereafter the "unit"), excluding without limitation the siren, the remote transmitters, the associated sensors and accessories, which proves to be defective in workmanship or material under reasonable use during the lifetime of the vehicle provided the following conditions are met: the unit was purchased from an authorized Directed dealer, the unit was professionally installed and serviced by an authorized Directed dealer; the unit will be professionally reinstalled in the vehicle in which it was originally installed by an authorized Directed dealer; and the unit is returned to Directed, shipping prepaid with a legible copy of the bill of sale or other dated proof of purchase bearing the following information: consumer's name, telephone number and address; the authorized dealers name, telephone number and address; complete product description, including accessories; the year, make and model of the vehicle; vehicle license number and vehicle identification number. All components other than the unit, including without limitation the siren, the remote transmitters and the associated sensors and accessories, carry a one-year warranty from the date of purchase of the same. ALL PRODUCTS RECEIVED BY DIRECTED FOR WARRANTY REPAIR WITHOUT PROOF OF PURCHASE WILL BE DENIED. This warranty is non-transferable and is automatically void if: the original purchaser has not completed the warranty card and mailed it within ten (10) days from the date of purchase to the address listed on the card; the unit's date code or serial number is defaced, missing or altered; the unit has been modified or used in a manner contrary to its intended purpose; the unit has been damaged by accident, unreasonable use, neglect, improper service, installation or other causes not arising out of defects in materials or construction. The warranty does not cover damage to the unit caused by installation or removal of the unit. Directed, in its sole discretion, will determine what constitutes excessive damage and may refuse the return of any unit with excessive damage.

TO THE MAXIMUM EXTENT ALLOWED BY LAW, ALL WARRANTIES, INCLUDING BUT NOT LIMITED TO EXPRESS WARRANTY, IMPLIED WARRANTY, WARRANTY OF MERCHANTABILITY, FITNESS FOR PARTICULAR PURPOSE AND WARRANTY OF NON-INFRINGEMENT OF INTELLECTUAL PROPERTY, ARE EXPRESSLY EXCLUDED; AND DIRECTED NEITHER ASSUMES NOR AUTHORIZES ANY PERSON OR ENTITY TO ASSUME FOR IT ANY DUTY, OBLIGATION OR LIABILITY IN CONNECTION WITH ITS PRODUCTS. DIRECTED DISCLAIMS AND HAS ABSOLUTELY NO LIABILITY FOR ANY AND ALL ACTS OF THIRD PARTIES INCLUDING ITS AUTHORIZED DEALERS OR INSTALLERS. DIRECTED SECURITY SYSTEMS, INCLUDING THIS UNIT, ARE DETERRENTS AGAINST POSSIBLE THEFT. DIRECTED IS NOT OFFERING A GUARANTEE OR INSURANCE AGAINST VANDALISM, DAMAGE OR THEFT OF THE AUTOMOBILE, ITS PARTS OR CONTENTS; AND HEREBY EXPRESSLY DISCLAIMS ANY

LIABILITY WHATSOEVER, INCLUDING WITHOUT LIMITATION, LIABILITY FOR THEFT, DAMAGE AND/OR VANDALISM. THIS WARRANTY DOES NOT COVER LABOR COSTS FOR MAINTENANCE, REMOVAL OR REINSTALLATION OF THE UNIT OR ANY CONSEQUENTIAL DAMAGES OF ANY KIND. IN THE EVENT OF A CLAIM OR A DISPUTE INVOLVING DIRECTED OR ITS SUBSIDIARY, THE VENUE SHALL BE SAN DIEGO COUNTY IN THE STATE OF CALIFORNIA. CALIFORNIA STATE LAWS AND APPLICABLE FEDERAL LAWS SHALL APPLY AND GOVERN THE DISPUTE. THE MAXIMUM RECOVERY UNDER ANY CLAIM AGAINST DIRECTED SHALL BE STRICTLY LIMITED TO THE AUTHORIZED DIRECTED DEALER'S PURCHASE PRICE OF THE UNIT. DIRECTED SHALL NOT BE RESPONSIBLE FOR ANY DAMAGES WHATSOEVER, INCLUDING BUT NOT LIMITED TO, ANY CONSEQUENTIAL DAMAGES, INCIDENTAL DAMAGES, DAMAGE TO VEHICLE, DAMAGES FOR THE LOSS OF TIME, LOSS OF EARNINGS, COMMERCIAL LOSS, LOSS OF ECONOMIC OPPORTUNITY AND THE LIKE. NOTWITHSTANDING THE ABOVE, THE MANUFACTURER DOES OFFER A LIMITED WARRANTY TO REPLACE OR REPAIR THE CONTROL MODULE SUBJECT TO THE CONDITIONS AS DESCRIBED HEREIN. THIS WARRANTY IS VOID IF THE UNIT HAS NOT BEEN PURCHASED FROM DIRECTED, OR AN AUTHORIZED DIRECTED DEALER, OR IF THE UNIT HAS BEEN DAMAGED BY ACCIDENT, UNREASONABLE USE, NEGLIGENCE, ACTS OF GOD, NEGLIGENCE, IMPROPER SERVICE, OR OTHER CAUSES NOT ARISING OUT OF DEFECT IN MATERIALS OR CONSTRUCTION.

Some states do not allow limitations on how long an implied warranty will last or the exclusion or limitation of incidental or consequential damages. This warranty gives you specific legal rights and you may also have other rights that vary from State to State.

This warranty is only valid for sale of product(s) within the United States of America. Product(s) sold outside of the United States of America are sold "AS-IS" and shall have NO WARRANTY, express or implied. This product may be covered by a Guaranteed Protection Plan ("GPP"). See your authorized Directed dealer for details of the plan or call Directed Customer Service at 1-800-876-0800.

Make sure you have all of the following information from your authorized Directed dealer:

A clear copy of the sales receipt, showing the following:

- o Date of purchase
- o Your full name and address
- o Authorized dealer's company name and address
- o Type of alarm installed
- o Year, make, model and color of the automobile
- o Automobile license number
- o Vehicle identification number
- o All security options installed on automobile
- o Installation receipts